

OPTIONS AND PLANNING DIMENSIONS

KONE TransitMaster™ 165/185 horizontal autowalk

KONE TRANSITMASTER™ PRODUCT RANGE

Well designed and manufactured autowalks are a must for today's highly demanding public areas. They are key to ensuring the smooth, efficient and safe flow of people traveling within a building's environment.

KONE prides itself on delivering the 'low risk' option to customers. We offer 'peace of mind' in terms of product design, customer support and project management, combined with the highest levels of efficiency and safety during the installation phase.

The versatile KONE TransitMaster escalator and autowalk range is ideal for new installations, and incorporates five specific models:

- TransitMaster 120 escalator
- TransitMaster 140 escalator
- TransitMaster 165 horizontal autowalk
- TransitMaster 185 horizontal autowalk
- InnoTrack horizontal autowalk

Each one is specifically designed to meet the exact demands and needs of the market sector, whether it's a more standard solution for the retail areas of an airport, or a mass transit airport or railway station system.



TRANSITMASTER™ 165/185 – THE IDEAL SOLUTIONS FOR MANAGING PEOPLE FLOW IN AIRPORTS

The KONE TransitMaster 165/185 is a horizontal autowalk primarily targeted towards the infrastructure segment. This segment covers airports, railways as well as stadiums and other transit centers. In this segment, horizontal autowalks are mostly used in airports and in two arrangements.

Shorter units of up to 60 m (e.g. TM165) to move passengers from gate to gate or within a terminal. Longer units of up to 100 m (e.g. TM185) to move passengers from one terminal to another.

In these applications, TransitMaster 165/185 is part of the total KONE solution offering together with other KONE products such as:

- Commercial escalators ----- e.g. KONE TravelMaster™ 110
- Heavy-duty escalators ----- e.g. KONE TransitMaster™ 120 and KONE TransitMaster™ 140
- Commercial inclined autowalks --- e.g. KONE TravelMaster™ 115
- Passenger elevators----- e.g. KONE MonoSpace®
- Goods elevators ----- e.g. KONE TransSys™
- Scenic elevators ----- based on KONE MonoSpace® or KONE MonoSpace® Special
- Modernization solutions ----- e.g. KONE EcoMod™2
- Automatic building doors

The KONE TransitMaster 165/185 is designed, from both a technical and visual point of view, to fulfill the main customer requirements of the target segments:

- Safety and reliability
- Optimized total cost of ownership
- High quality in terms of technical performance and visual appearance
- Flexible offering to cover the wide range of needs of the segment
- Elegant, modern and harmonized design

Overview of technical specifications

KONE TRANSITMASTER 165/185 BASIC DATA*		
	TransitMaster 165	TransitMaster 185
Inclination	Maximum 6°	Maximum 6°
Maximum length	60 m	100 m**
Speed	0.4m/s with inverter, 0.5m/s, 0.65m/s, 0.75m/s	0.4m/s with inverter, 0.5m/s, 0.65m/s, 0.75m/s
Pallet width	1000 mm, 1200 mm, 1400 mm	1000 mm, 1200 mm, 1400 mm
Balustrade type	Glass, sandwich panels, solid inclined	Glass, sandwich panels, solid inclined
Balustrade height	1000 mm	1000 mm
Handrail type	C-type	C- and V-type
Pallet chains	Inside roller chains	Outside roller chains
Operational environment	Indoor, semi-outdoor	Indoor, semi-outdoor
Duty cycle	20 – 24 hours/day***	20 – 24 hours/day***
Typical service life	100,000 hours	200,000 hours

* Other custom-built specifications available on request

** Longer units are available via order engineering. Please contact KONE for more information.

*** 24 hours duty cycle is possible with additional maintenance

ECO-EFFICIENCY

KONE firmly believes that sustainable buildings are our future. We are committed to helping customers achieve their environmental objectives by providing environmentally responsible products and services.

- Stand-by speed operation reduces the autowalks speed when no passengers are traveling, thus further reducing energy consumption and increasing equipment lifetime.
- The availability of a lubrication-free step chain means no oil, a cleaner autowalk and environment, reduced fire hazard, simpler cleaning and easier maintenance.
- Various LED lighting solutions allows an energy saving of up to 80% compared to conventional lighting.
- Reduced escalator running speed of 0.4 m/s not only enhances passenger safety but also saves energy depending on passenger traffic.
- All of our production operations are certified according to the ISO 14001 standard.



SAFETY OPTIONS

The standard safety features of the KONE TransitMaster 165/185 according to the EN 115-1:2008 + A1:2010 safety code are the following:

- Emergency stop buttons for passengers are available at each end of the autowalk
- Broken pallet chain (chain tension) switches in the return station which stop the autowalk in case of failure of the pallet chain
- Handrail inlet switches with contacts at the handrail inlets into the balustrade heads
- Comb plate impact device switches which stop the autowalk in case objects become trapped between the comb teeth and the moving pallet band
- Pallet sag switches, which stop the autowalk if a pallet sags by more than 5 mm before it enters the comb
- Pallet band locking device
- Speed sensor system, which electronically monitors the motor for over/under speeds and pallet band reversal
- Motor thermal protection for temperature monitoring
- Step guards at each end
- Main switch with thermal and magnetic release
- Stop switches for engineers' within drive end and return end pits
- Sockets for inspection use installed in the drive end and return end machine compartments
- Skirt deflector brushes
- Access cover contacts
- Handrail speed monitor
- Missing pallet monitor
- Diagnostic display
- Additional emergency stop button

Other safety and monitoring functions, such as KONE Remote Monitoring and E-link, are available on request.

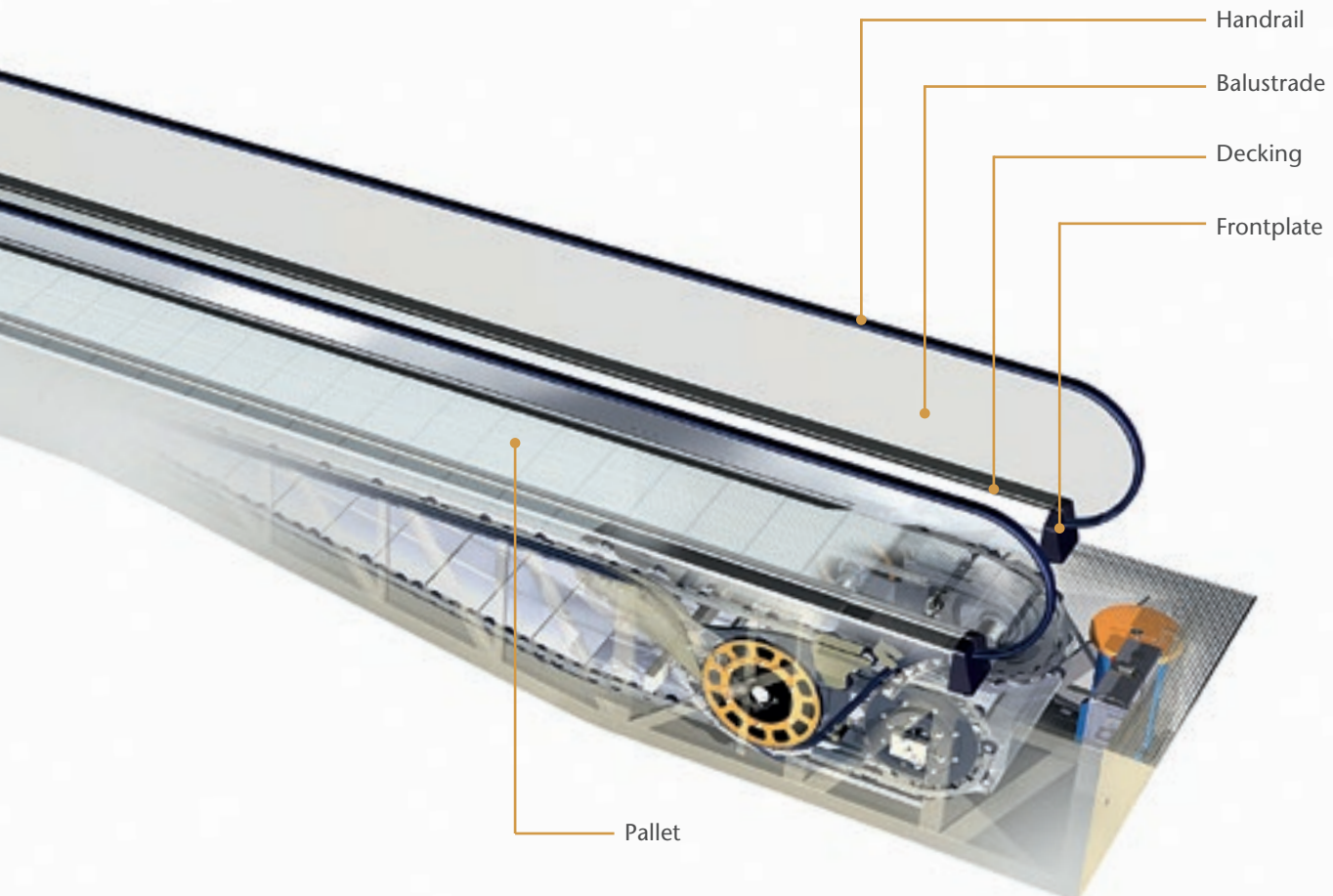

VISUAL OPTIONS

ACCESS COVER

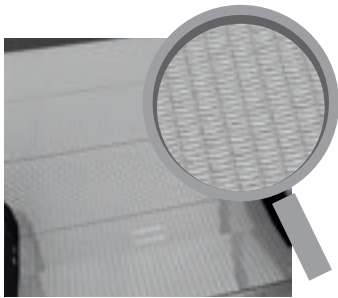

Stainless steel surface with punched diamond pattern (available in 304# and 443#)

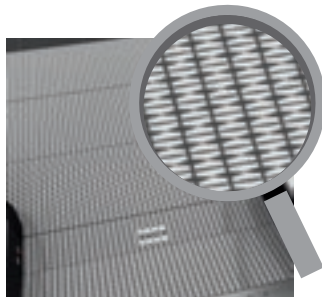

Black painted stainless steel surface with punched diamond pattern (available in 304# and 443#).



Natural ribbed aluminum

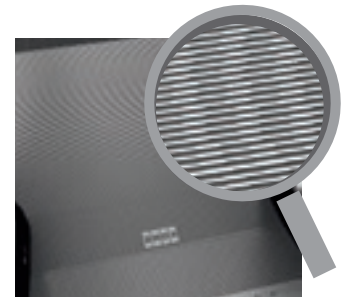

Ribbed aluminum with black grooves

COMB

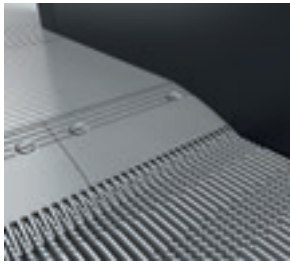

Aluminum comb segments

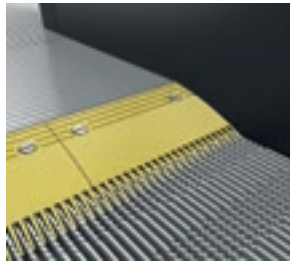

Aluminum comb segments with yellow coating

SKIRT

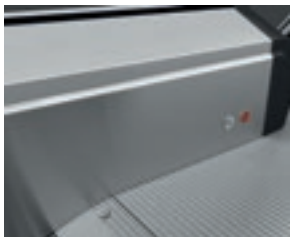

Brushed satin stainless steel skirt with clear anti-friction coating



Sheet steel skirt with black anti-friction coating

SKIRT BRUSH HOLDER

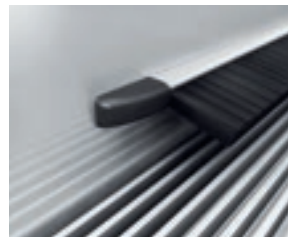

Clear anodized aluminum

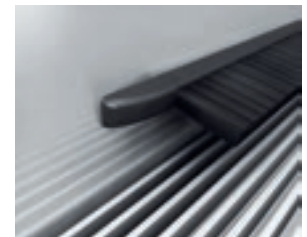

Black anodized aluminum

DECKING



Silver powder coating (RAL9007)



Natural anodized aluminum



Brushed satin stainless steel



Center decking in same material as decking

FRONTPLATE

TM165



Satin polished stainless steel



Black plastic

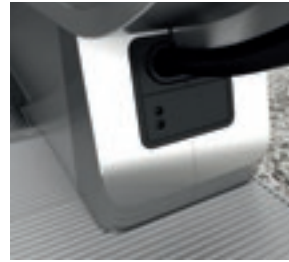

Stainless steel frontplate for solid balustrade



Black plastic frontplate for solid balustrade

TM185



Stainless steel



Black plastic

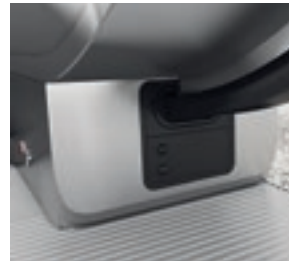

Stainless steel for solid balustrade



Black plastic for solid balustrade

BALUSTRADE

TM165



Clear glass balustrade panels



Stainless steel sandwich panels



Brushed stainless steel solid inclined balustrade panels

TM185

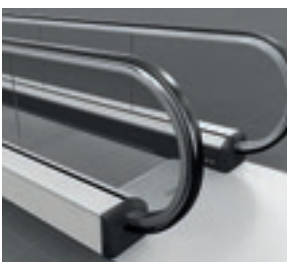

Clear glass balustrade panels



Stainless steel sandwich panels



Brushed stainless steel solid inclined balustrade panels

HANDRAIL



Black



Black with white demarcation inserts



Red

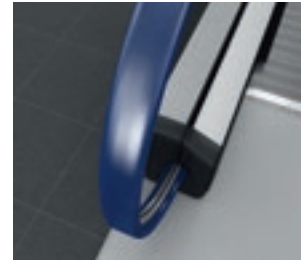

Blue



Green



Brown



Beige



Grey

PALLET COLOR

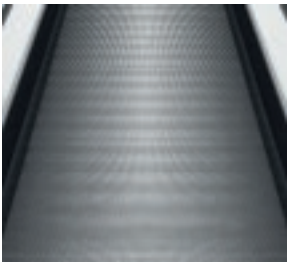

Natural aluminum

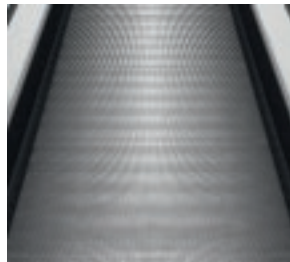

Silver aluminum

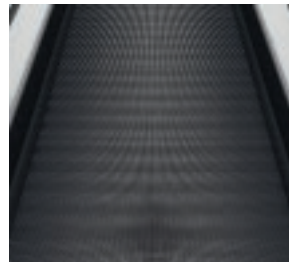

Black aluminum pallets with metal color ribs



Black stainless steel pallet (only for selected markets)

Pallet demarcation

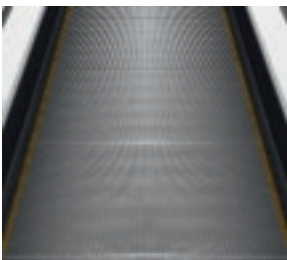

Yellow painted demarcation on two sides of pallet (only with alu pallet)

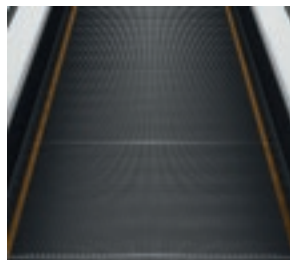

Yellow plastic inserts demarcation on two sides of pallet (only with black stainless steel pallet)

ADDITIONAL OPTIONS



Additional emergency stop button (EN115-1:2008:+A1:2010 requirement)



Diagnostic display

LED LIGHTING

Continuous LED handrail lighting



White

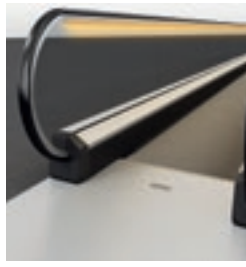

Yellow



Red



Blue

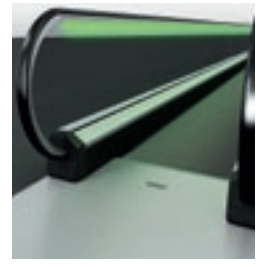

Green

Continuous LED skirt lighting



White

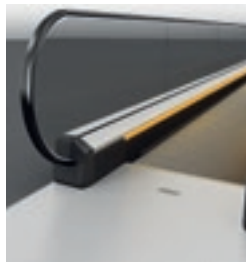

Yellow

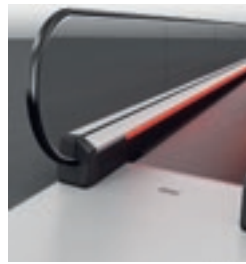

Red



Blue

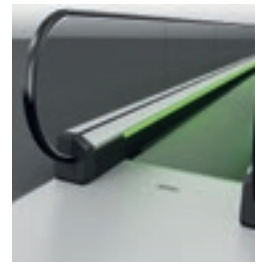

Green

LED skirt spot lighting

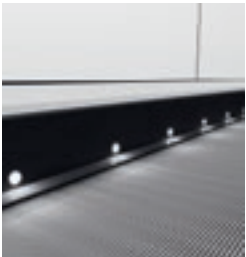

LED skirt spotlighting

LED comb light*



* Same colour options as in continuous LED handrail and skirt lighting

LED options specification

LED handrail lighting

- Static continuous lighting
- Several color options available (see above)
- Add-on solution for existing units

LED skirt lighting

- Static continuous lighting
- Several color options available (see above)

LED skirt spot lighting

- Decorative lighting
- White light

LED comb light

- Static or flashing option
- Several color options available (white, yellow, red, blue and green)

ADDITIONAL LIGHTING



LED traffic lights located in the decking



Pallet demarcation lighting

KONE TRANSITMASTER™ 165 PLANNING DIMENSIONS

Architectural planning data

0-6° inclination, up to 60 m length, inside roller chain

Code: EN 115-1:2008 + A1:2010

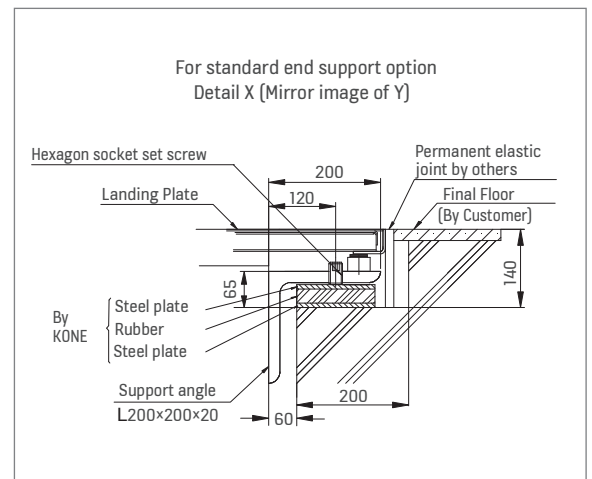
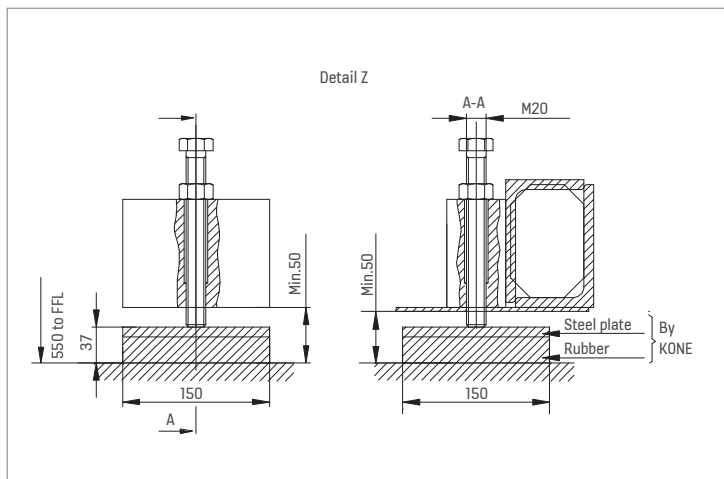
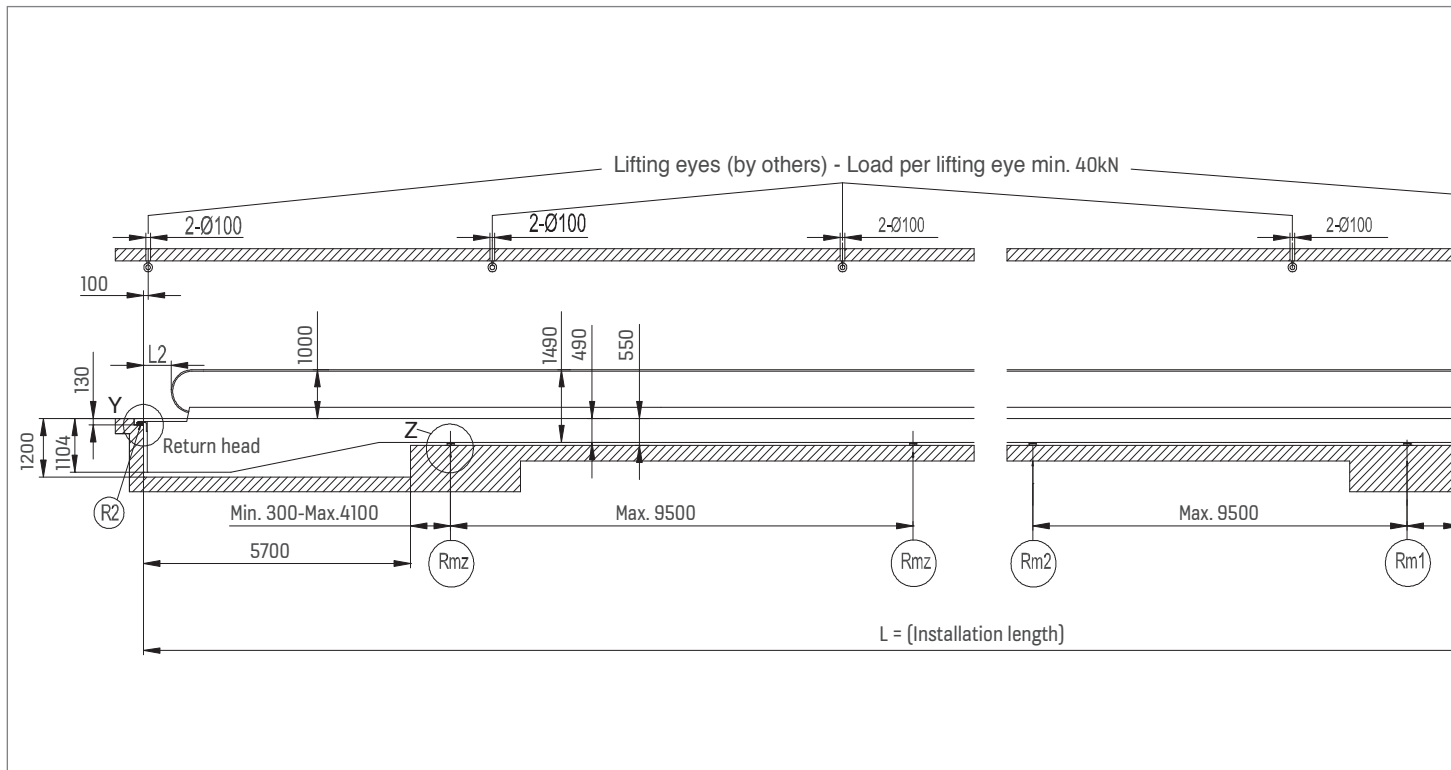

REACTION FORCE [kN]

Pallet width	R1	R2	RM1-RMZ
1000	50	38	120
1200	55	43	135
1400	60	48	150

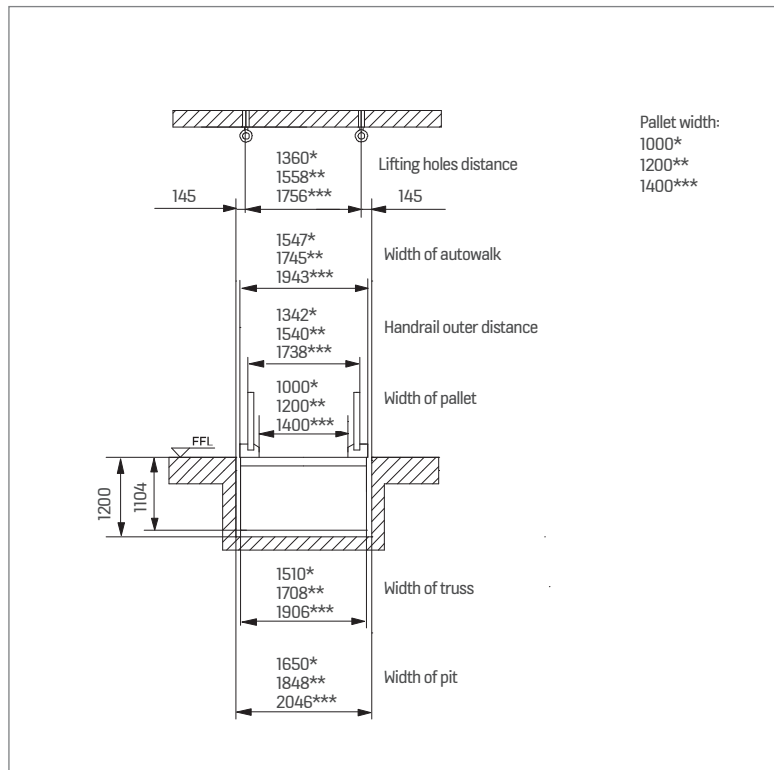
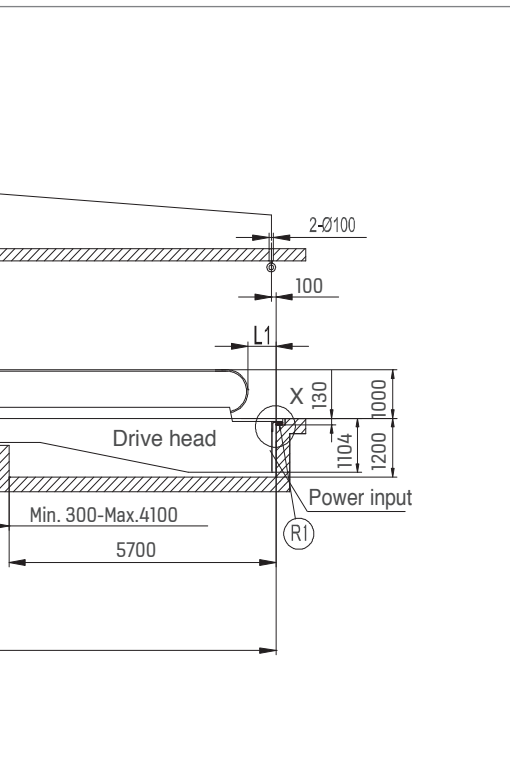

- All dimensions are in millimeters.
- The floor opening dimensions shown are clear plumb line dimensions between supports.
- The figures shown for the support loads include the dead weight of the autowalk and the live passenger load (500 kg/m²).
- Electrical connection required at the drive end. Voltage: 400 Volt 50 Hz 3-phase+neutral+earth.
- Load per lifting hole or lifting eye depending on length of sections = 30-40 kN.
- An access opening 2.50 m wide and 2.50 m high into and through the building is required for installation.

Note:
 If you would like to obtain the exact dimensions for your specific project, we recommend you to contact your local KONE sales representative.

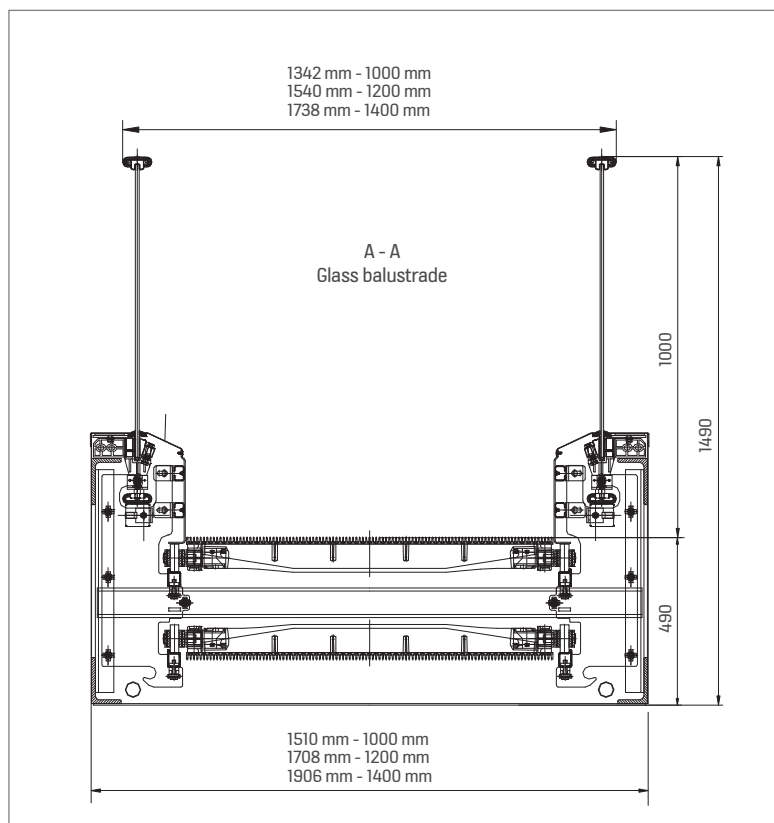

KONE TRANSITMASTER™ 185 PLANNING DIMENSIONS

Architectural planning data

0-6° inclination, up to 100 m length, outside roller chain

Code: EN 115-1:2008 + A1:2010

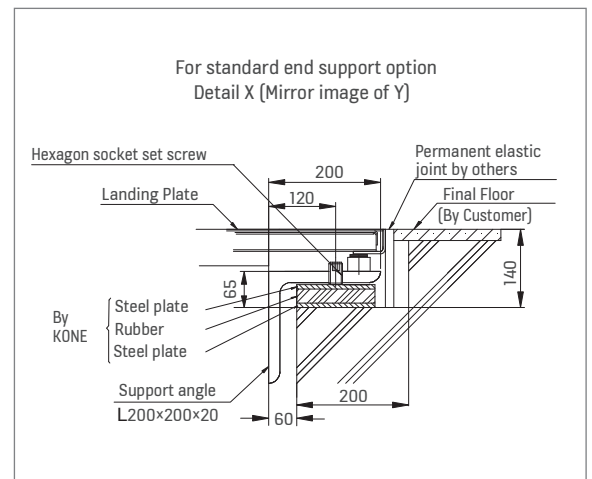
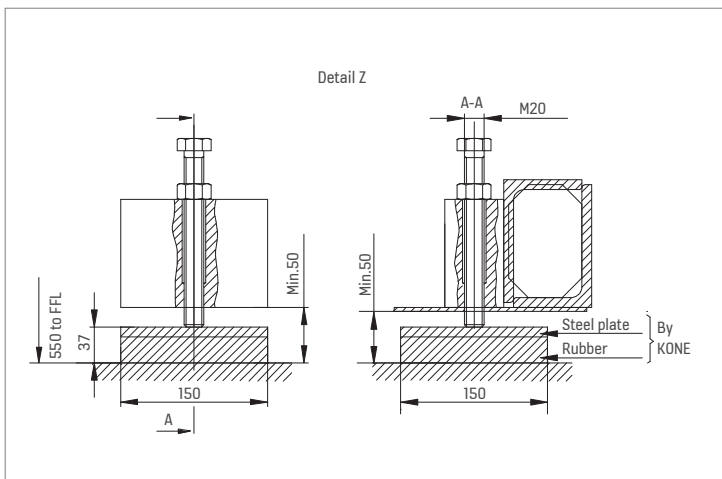
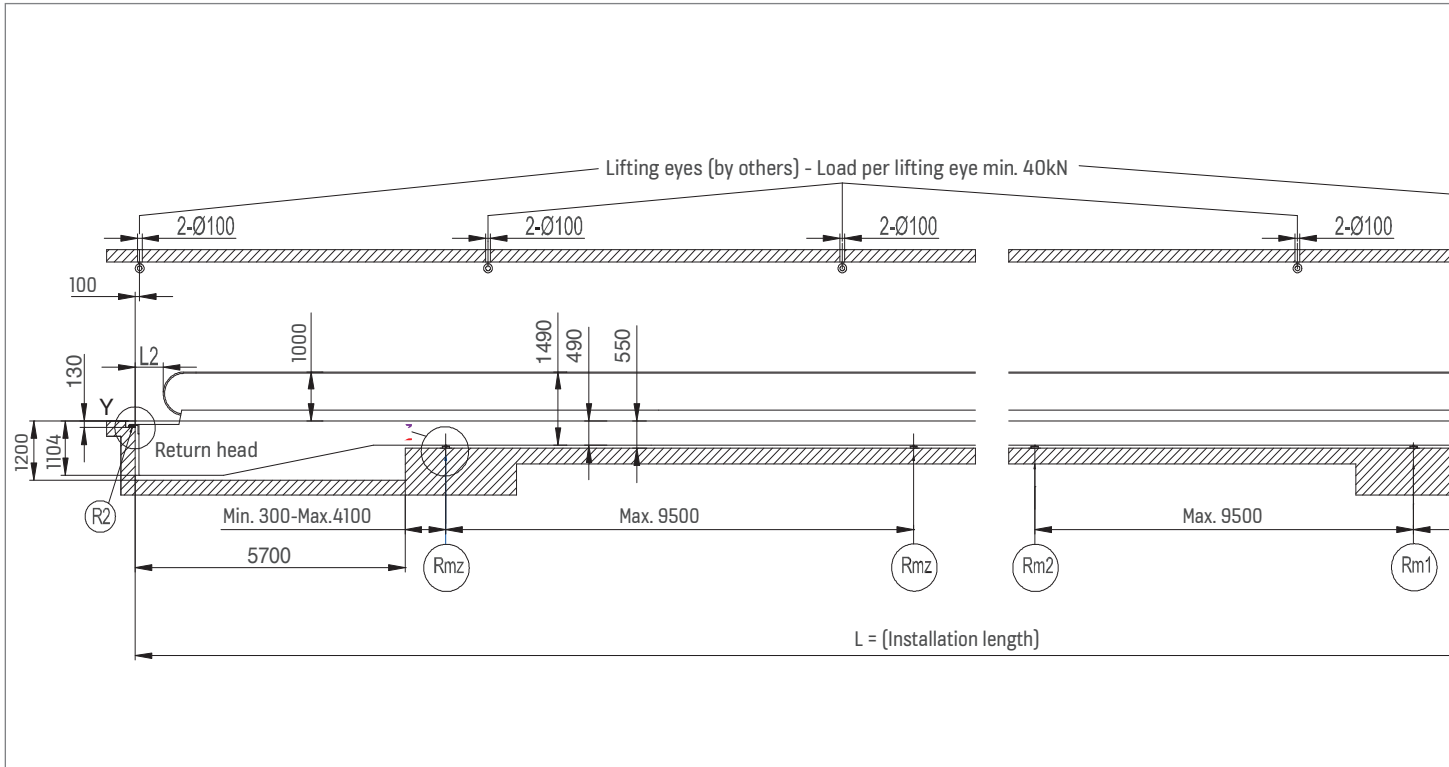

REACTION FORCE [kN]

Pallet width	R1	R2	RM1-RMZ
1000	50	38	120
1200	55	43	135
1400	60	48	150

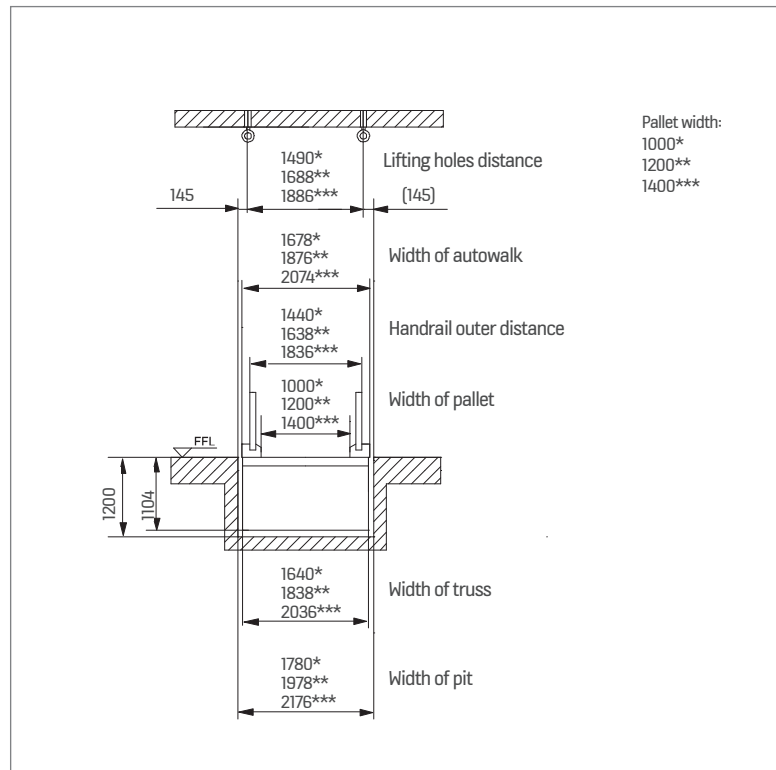
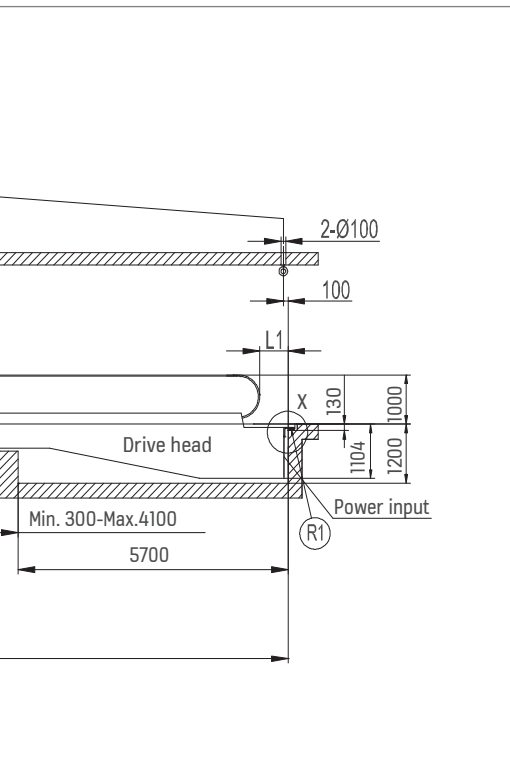

- All dimensions are in millimeters.
- The floor opening dimensions shown are clear plumb line dimensions between supports.
- The figures shown for the support loads include the dead weight of the autowalk and the live passenger load (500 kg/m²).
- Electrical connection required at the drive end. Voltage: 400 Volt 50 Hz 3-phase+neutral+earth.
- Load per lifting hole or lifting eye depending on length of sections = 30-40 kN.
- An access opening 2.50 m wide and 2.50 m high into and through the building is required for installation.

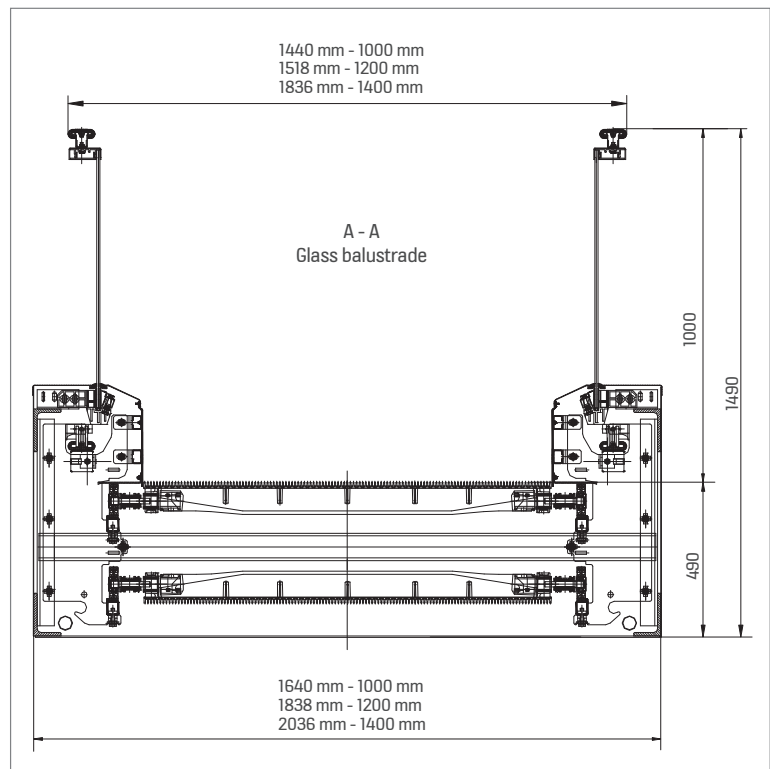

Note:
 If you would like to obtain the exact dimensions for your specific project, we recommend you to contact your local KONE sales representative.





KONE provides innovative and eco-efficient solutions for elevators, escalators, automatic building doors and the systems that integrate them with today's intelligent buildings.

We support our customers every step of the way; from design, manufacturing and installation to maintenance and modernization. KONE is a global leader in helping our customers manage the smooth flow of people and goods throughout their buildings.

Our commitment to customers is present in all KONE solutions. This makes us a reliable partner throughout the life cycle of the building. We challenge the conventional wisdom of the industry. We are fast, flexible, and we have a well-deserved reputation as a technology leader, with such innovations as KONE MonoSpace®, KONE NanoSpace™ and KONE UltraRope®.

KONE employs close to 50,000 dedicated experts to serve you globally and locally.

KONE Corporation
www.kone.com